



FEATURES

Solid brass construction
 Crystal clear water flow (laminar aerator)
 Adjustable temperature limit stop
 Press pop-up drain with overflow included #ABDR00899
 3/8" connection

Ceramic cartridge #ABCA04075

Flow rate: 1.2 gpm - 4.5L/min (60psi)

Mounting hole: 1 3/8"

Counter depth: min 1-3/8" max 2-3/8"

FINISHES

Polished chrome (PC) Brushed Nickel PVD (BNVD)
 Electro Black (EBK)

CERTIFICATIONS & COMPLIANCE

ASME A112.18.1

NSF/ANSI 61 and 372

CSA B125.1

EPA WaterSense®

ADA

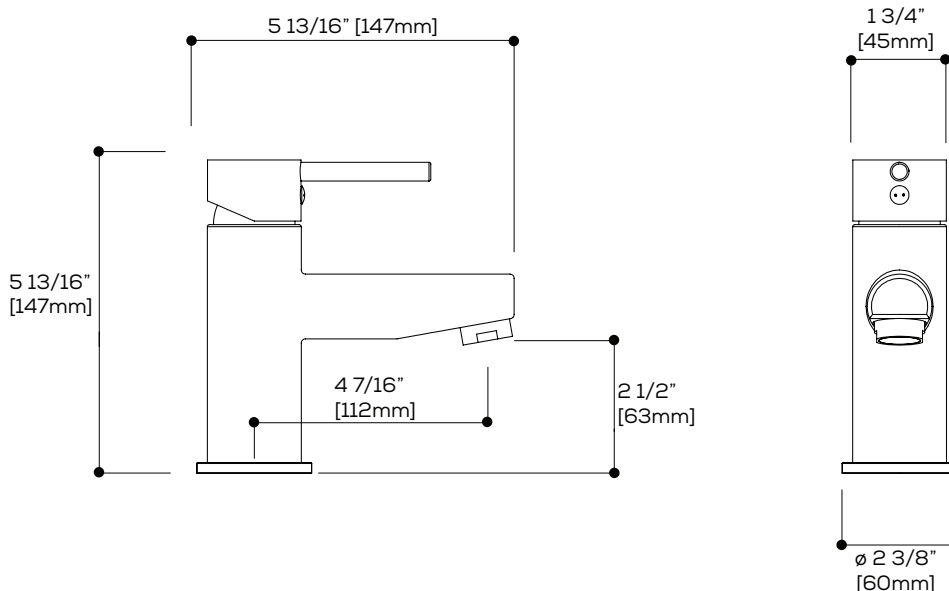

Quick access to warranty
 and support:

